

Revision date: Jun. 18th, 2023 | Applicable for IEC certified products

This manual applies to photovoltaic GG modules ( “GG modules” , also commonly known as Double Glass Modules) manufactured by Yingli Energy (China) Company Limited ( “Yingli Solar” ), and is explicitly written for qualified professionals ( “Installer” or “Installers” ), including without limitation licensed electricians and RAL certified PV installers.

## INTRODUCTION

Thank you for choosing Yingli Solar as your PV module provider. We appreciate your business! This manual contains important information pertaining to the electrical and mechanical installation and maintenance of GG modules, and contains safety information that you must read carefully and be familiar with before handling, installing, and/or maintaining Yingli Solar GG modules.

Yingli Solar does not assume responsibility and expressly disclaims liability for losses, damages, or expenses arising out of, or in any way connected with this Installation and User Manual. Yingli Solar assumes no responsibility for any infringement of patents or other rights of third parties, which may result from using Yingli Solar GG modules. No license is granted expressly or by implication or under any patent or patent rights. The information in this manual is believed to be reliable, but does not constitute an expressed or implied warranty. Yingli Solar reserves the right to make changes to its GG modules and other products, their specifications or this manual without prior notice.

Yingli Solar and its subsidiaries are not liable for any damages caused by inappropriate installation, use or maintenance of Yingli Solar GG modules, including without limitation damages, losses and expenses caused by non-observance of the instructions of this manual or caused by or in connection with products of other manufacturers.

Yingli Solar GG modules are designed to meet the requirements for the standards IEC 61215 and IEC 61730, application class A. Modules rated for use in this application class may be used in systems operating at greater than 50 V DC or 240 W, where general contact access is anticipated. Modules qualified for safety through IEC 61730-1 and IEC 61730-2 and within this application class are considered to meet the requirements for safety class II. In the course of the GG module certification process, the compliance of this manual with the certification requirements has been verified by an independent certification laboratory.

This Installation and User Manual is available in different languages. In cases of discrepancy between versions, the English language version shall control.

Failure to comply with the requirements listed in this manual will invalidate the Limited Warranty for GG Modules as provided by Yingli Solar at the time of sale to the direct customer. Additional recommendations are provided to enhance safety practices and performance results. Please provide a copy of this manual to the PV system owner for their reference, and inform them of all relevant aspects of safety, operation and maintenance.

## SAFETY

### General

You must understand and follow all applicable local, state and federal regulations and standards for building construction, electrical design, fire and safety, and must check with local authorities to determine applicable permitting requirements before attempting to install or maintain GG modules.

Rooftop PV systems should only be installed on houses that have been formally analyzed for structural integrity, and confirmed to be capable of handling the additional load of PV system components, including GG modules, by a certified building specialist or engineer.



For your safety, do not attempt to work on a rooftop until safety precautions have been identified and taken, including without limitation fall protection measures, ladders or stairways, and personal protective equipment.

For your safety, do not install or handle GG modules under adverse conditions, including without limitation strong or gusty winds, and wet or frosted roof surfaces.

GG modules are photovoltaic products made of tempered glass, encapsulant, ribbon, cells and junction boxes. Figure 1 is an illustration of the GG module components.

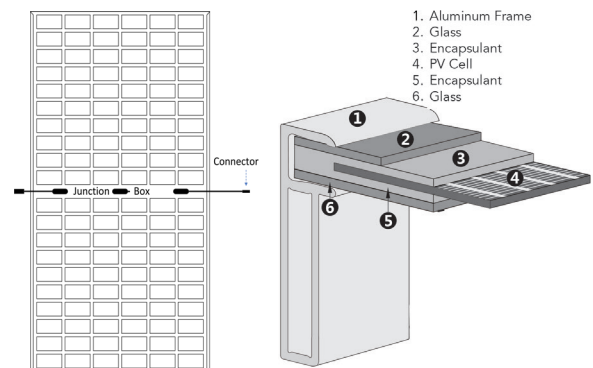

Figure 1: Module components and cross-section of the laminated assembly

### Electrical

GG modules can produce current and voltage when exposed to light of any intensity. Electrical current increases with higher light intensity. DC voltage of 30 Volts or higher is potentially lethal. Contacting live circuitry of a PV system operating under light can result in lethal electric shock.



De-energize GG modules by removing them entirely from light or by covering their front and rear surfaces with an opaque material. Regard the safety regulations for live electrical equipment when working with modules that are exposed to any light. Use insulated tools and do not wear metallic jewelry while working with GG modules.

In order to avoid arcing and electrical shock, do not disconnect electrical connections under load. Faulty connections can also result in arcing and electrical shock. Keep connectors dry and clean, and ensure that they are in proper working condition. Never insert metallic objects into the connectors, or modify them in any way in order to secure an electrical connection.

Do not touch or handle GG modules with broken glass or separated frames, unless the modules are disconnected and you are wearing proper personal protective equipment. Avoid handling GG modules when they are wet unless cleaning the GG modules as directed in this manual. Never touch electrical connections that are wet without protecting yourself with insulated gloves.

## Transport and Handling

Yingli Solar GG modules must be transported in the supplied packaging only, and kept in the packaging until they are ready to be installed. At time of receipt, please verify that the delivered product is in fact the product ordered. The product name, subname and serial number of each laminate are clearly marked on the outside of each packing box.

Protect pallets against movement and exposure to damage during transportation. Do not exceed the maximum allowable height of pallets to be stacked, as indicated on the pallet packaging. Secure pallets from falling over. If pallets are stored temporarily outside please place a protective covering over the pallet to protect it from direct weathering and do not stack pallets.

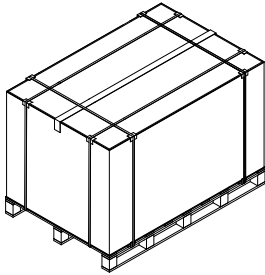

Figure 2: Pallet of GG modules

At the installation site, take care to keep modules and their electrical contacts clean and dry before installation. If connector cables are left in damp conditions then the contacts may corrode. Any module with corroded contacts should not be used. Yingli Solar GG modules are heavy, and should be handled with care, so non-slip gloves are required when handling and installation. Please never use the junction box or cables as a grip. Do not exert mechanical stress on the cables. Never step on GG modules, never drop or place heavy objects on them. Be careful when placing GG modules on hard surfaces, and secure them from falling. Broken glass can result in personal injury. GG modules with broken glass cannot be repaired and must not be used. Broken or damaged GG modules must be handled carefully and disposed of properly.

For unpacking **framed** GG modules, ensure that the pallet stands firm and not inclined in such a way that modules can slide out during the unpacking process (opening side should not face downwards). Carefully cut and remove the cardboard of one short side of the box. Pay attention to not damage the modules during the cutting process. Cut and remove the inner transverse security straps around the modules, then remove the wooden support inside the box. Cut the inner longitudinal security straps around the modules from the bottom part of the pallet, then cut the cardboard and the inner packing belts around the modules. Pull out the modules slowly from the back side of the module (see Figure 3), then carry one module with two people. When unpacking on non-horizontal place, measures should be needed to protect modules.

For the **framed** GG modules with upright packaging, please refer to the attached “Transfer Requirements” and “Unpacking Instructions” for details.

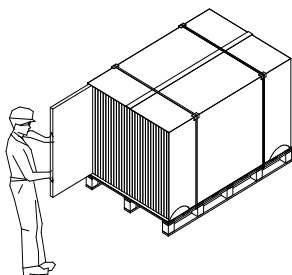

Figure 3: Cutting cardboard and pull out modules

Check GG modules for damage due to transportation before installation. Do not install damaged modules. Please contact the company you have purchased the Yingli Solar GG modules for information or complaints.

GG module surfaces are susceptible to damage that could affect the performance or safety of the module. Do not damage or scratch the GG module surfaces, and do not apply paint or adhesive to any of the surfaces, including the frame. For your safety, do not disassemble or modify the modules in any way. Doing so may degrade performance or cause irreparable damage and will void any applicable warranties.

If it is necessary to store GG modules prior to installation, the GG modules should remain inside the packaging and protected from exposure that could compromise the durability of the packaging.

## Fire

Yingli Solar GG Modules have a fire resistance rating in accordance with the IEC 61730-2 certification, while the materials of modules please refer to the test report and CDF document. When GG modules are mounted on the rooftops, the roof must have a fire resistant covering suitable for this application. GG modules are electrical generating devices that may affect the fire safety of a building.

The use of improper installation methods and/or defective parts may result in the unexpected occurrence of an electrical arc during operation. In order to mitigate the risk of fire in this event, GG modules should not be installed near flammable liquids, gases or locations with hazardous materials.

In the event of a fire, GG modules may continue to produce a dangerous voltage, even if they have been disconnected from the inverter, partly or entirely destroyed, or the system wiring has been compromised or destroyed. In the event of fire, inform the fire crew about the particular hazards from the PV system, and stay away from all elements of the PV system during and after a fire until the necessary steps have been taken to make the PV system safe.

## APPLICATION INFORMATION

### Application Restrictions

Yingli Solar GG modules must be mounted on appropriate structures, positioned on buildings, the ground, or other places suitable for GG modules (e.g. carports, building facades or PV trackers). GG modules must not be mounted on moving vehicles of any kind. Yingli Solar GG modules must not be installed in locations where they could be submerged in water.

Yingli Solar GG modules must not be sited in locations where aggressive substances, such as salt or salt-water, or any other type of corrosive agent, could affect the safety and/or performance of the GG modules.

Artificially concentrated light must not be directed on the front and rear surfaces of GG modules.

### Design Recommendations

Yingli Solar recommends that GG modules shall be mounted at a minimum tilt angle of 10 degrees to allow for proper self-cleaning from normal rain showers.

GG modules are recommended to be installed at an optimized tilt angle to maximize the energy output. It is roughly equal to the latitude of the project site as a rule of thumb, facing the equator. But always to design based on local situations to find out the optimum one.

Partial or complete shading of a GG module or modules can significantly reduce system performance. Yingli Solar recommends minimizing the amount of shade throughout the year to increase the amount of energy produced by the GG modules.

Lightning protection is recommended for PV systems that are to be installed in locations with high probability of lightning strikes.

High system voltages could be induced in the event of an indirect lightning strike, which could cause damage to PV system components. The open area of wire loops should be minimized (see Figure 4), in order to reduce the risk of lightning induced voltage surges.

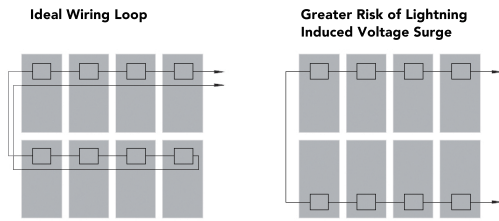

Figure 4: Wire loop design recommendation

## Climate Conditions

GG modules may be installed in the following conditions for more than 30 years. In addition to the required IEC certification, GG modules have also been tested to verify resistance to ammonia fumes that may be present around barns sheltering cattle, as well as suitability for installation in humid (coastal) areas and areas of high sand storms.

Table 1: Environment of installation

Operating temperature	- 40°C to + 85°C
Storage temperature	- 20°C to + 50°C
Humidity	< 85% RH
Altitude	≤ 2000 m

The modules have been evaluated by TUV according to IEC61215 for a maximum positive design loading of 3600 Pa, and negative design loading 1600 Pa, with 1.5 times safety factor. While for detailed information about the installation method and its corresponding mechanical load, please refer to the “Installation and User Manual Supplement “.

The mechanical load bearing is dependent upon the mounting methods used and failure to follow the instructions in this manual may result in different capabilities to withstand snow and wind loads.

The system installer must ensure that the installation methods used meet these requirements and any local codes and regulations.

## ELECTRICAL INSTALLATION

### Electrical Configuration

Under normal conditions, a GG module is likely to experience conditions that produce more current and/or voltage than reported at Standard Test Conditions (Irradiance: 1000 W/m<sup>2</sup>, 25°C cell temperature and AM 1.5). The short-circuit current ( $I_{sc}$ ) should be multiplied by a factor of 1.25 based on the highest ambient temperature recorded, and the open-circuit voltage ( $V_{oc}$ ) should be multiplied by a factor of up to 1.25 based on the lowest ambient temperature recorded for the installation location when determining component voltage ratings, conductor current ratings, fuse sizes, and size of controls connected to the PV output.

This maximum voltage should not be exceeded at any time and, as the voltage of the module increases, above datasheet values, at operating temperatures below 25°C, then these need to be taken into account when designing a PV system.

Voltages are additive when GG modules are connected directly in series, and module currents are additive when GG modules are connected directly in parallel (see Figure 5). GG modules with different electrical characteristics must not be connected directly in series. The use of unsuitable third-party electronic devices connected to GG modules may lead to mismatching, and must be installed according to the manufacturer’s specified instructions.

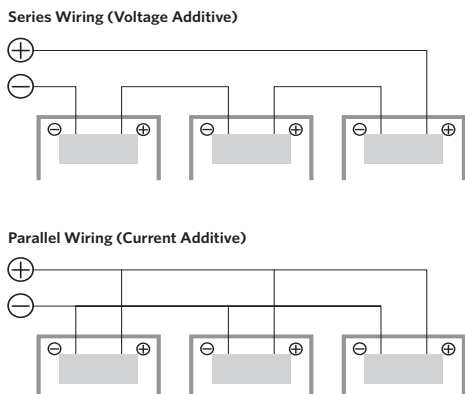

Figure 5: Electrical diagrams of series and parallel wiring

The maximum voltage of the system must be less than the maximum certified voltage, 1500V typically, and the maximum input voltage of the inverter and of the other electrical devices installed in the system. To ensure that this is the case, the open circuit voltage of the array string needs to be calculated at the lowest expected ambient temperature for the location. This can be done by using the following formula.

$$\text{Max system voltage} \geq N \times V_{oc} \times [1 + \beta_{Voc} \times (T_{min} - 25)]$$

Where	N	Number of modules in series
	$V_{oc}$	Open circuit voltage of each module (refer to product label or datasheet)
	$\beta_{Voc}$	Thermal coefficient of open circuit voltage for the module (refer to datasheet)
	$T_{min}$	The lowest ambient temperature

When the modules connect in parallel, the output current will be equal to the sum of each branch current. It is suggested that every series module string should be fused prior to be connected with other strings. Please refer to the applicable regional and local codes for additional fuse requirements.

An appropriately rated overcurrent protection device must be used when the reverse current could exceed the value of the maximum fuse rating of the module. An overcurrent protection device is required for each series string if more than two series strings are connected in parallel.

### Cables and Wiring

Yingli Solar GG modules are provided with two (2) stranded, sunlight resistant output cables that are terminated with PV connectors ready for most installations. The positive (+) terminal has a female connector while the negative (-) terminal has a male connector. The module wiring is intended for series connections [i.e. female (+) to male (-) interconnections, see Figure 6], but can also be used to connect suitable third-party electrical devices that may have alternative wiring configurations so long as the manufacturer’s instructions are followed.

Use field wiring with suitable cross-sectional areas that are approved for use at the maximum short-circuit current of the GG module. Yingli Solar recommends to use only sunlight resistant waterproof cables qualified for direct current (DC) wiring in PV systems. The minimum wire size should be 4 mm<sup>2</sup>.

Table 2: Required minimum field wiring specifications

	Testing standard	Wire size (mm <sup>2</sup> )	Temperature rating (°C)
Required minimum field wiring	EN 50618	4	- 40 to + 90

Cables should be fixed to the mounting structure in such a way that mechanical damage of the cable and/or the module is avoided. Do not apply stress to the cables, the minimum cable bending radius should be 40 mm. For fixing, use appropriate means, such as sunlight resistant cable ties and/or wire management clips specifically designed to attach to the mounting structure. While the cables are sunlight resistant and waterproof, where possible, avoid direct sunlight exposure and water immersion of the cables.

### Connectors

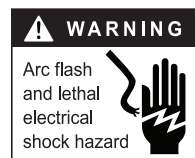

Keep connectors dry and clean, and ensure that connector caps are hand tight before connecting the modules. Do not attempt making an electrical connection with wet, soiled or otherwise faulty connectors. Avoid sunlight exposure and water immersion of the connectors. Avoid connectors resting on the ground or roof surface.

Faulty connection can result in arcs and electrical shock. Check that all electrical connections are securely fastened. Make sure that all locking connectors are fully engaged and locked.

Modules must not be interconnected using connectors from different manufacturers and/or of different types. If modules having such different connectors need to be interconnected, a qualified professional may replace connectors according to the manufacturers’ specified instructions such that an interconnection can be made with connectors from the same manufacturer and the same type.

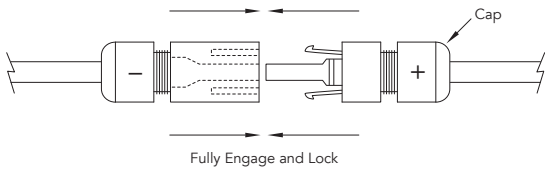

Figure 6: Connector of the plugs

## Bypass Diodes

The junction boxes used with Yingli Solar GG modules contain bypass diodes wired in parallel with the PV cell strings. In the case of partial shading, the diodes bypass the current generated by the non-shaded cells, thereby limiting module heating and performance losses. Bypass diodes are not overcurrent protection devices.

Bypass diodes divert current from the cell strings in the event of partial shading. See Figure 7 for a diagram showing how the cell strings are electrically connected with the diodes. In the event of a known or suspected diode failure, installers or maintenance providers should contact the company which the GG modules were purchased from. Never attempts to open the junction box of a Yingli Solar GG module yourself.

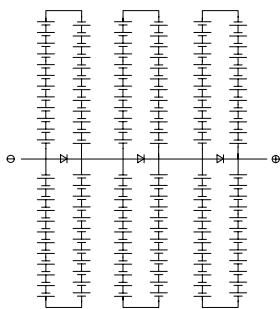

Figure 7: Electrical circuitry of cells and bypass diodes

## PV Array Grounding

For optimal performance, Yingli Solar recommends that the negative pole of the PV array be connected to ground.

## Equipment Grounding

The frame of the PV module, as well as any exposed non-current-carrying metal parts of fixed equipment that are able to become energized by the PV system, must be connected to the equipment grounding conductor (EGC) in order to prevent electrical shock. Even when applicable regulations, code requirements and standards do not require safety-related grounding, Yingli Solar recommends grounding all PV module frames in order to ensure the voltage between electrically conductive equipment and earth ground is zero in all circumstances.

Proper equipment grounding is achieved by bonding all exposed non-current-carrying metal equipment continuously to one another using an appropriately sized EGC or racking system that can be used for integrated grounding (see Option B in Grounding Methods below).

Yingli Solar PV modules employ a coated aluminium frame for corrosion resistance. In order to properly ground the module frame, the coating must be penetrated.

The potential for corrosion due to the electrochemical action between dissimilar metals in contact is minimized if the electrochemical voltage potential between the dissimilar metals is low. The grounding method must not result in the direct contact of dissimilar metals with the aluminium frame of the PV module that will result in galvanic corrosion. An addendum to UL Standard 1703 "Flat Plate Photovoltaic Modules and Panels" recommends metal combinations not exceed an electrochemical potential difference of 0.5 Volts.

The frames have pre-drilled holes marked with a grounding sign (see Figure 8). These holes should be used for grounding purposes and must not be used for mounting the PV modules. Do not drill additional holes into the frames.

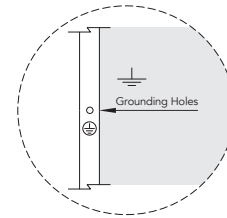

Figure 8: Grounding hole detail

The following grounding methods are available:

Option A: Screw assembly (see Figure 9)

1. The grounding screw must be installed on the designed grounding hole and must be stainless steel screw.
2. The screw first passes through the stainless steel flat washers. The screw rods pass through the grounding holes outwards, and then pass through the stainless steel piercing washers, grounding terminal, stainless steel flat washers, and stainless steel spring washers in turn, and finally fix them with stainless steel backing nuts.
3. Tighten the backing nut to a torque of not less than 4 N·m to ensure that the backing nut can securely hold the screw.
4. Install piercing washers of appropriate size, and ensure that the protrusions of the piercing washers reliably pierce the frame of the module.

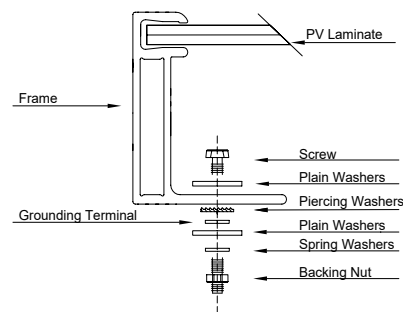

Figure 9: Grounding screw assembly detail

Option B: Racking manufacturer integrated grounding methods

Yingli Solar PV modules can be grounded by bonding PV modules to a grounded racking system. Integrated grounding methods must be certified for grounding PV modules and must be installed in accordance with the specified instructions of their respective manufacturers.

Option C: Additional third-party grounding devices

Yingli Solar PV modules can be grounded using third-party grounding devices so long as they are certified for grounding PV modules and the devices are installed according to the manufacturer's specified instructions.

## MECHANICAL INSTALLATION

Yingli Solar GG Modules have been certified for a maximum positive design loading of 3600 Pa, and negative design loading 1600 Pa, with 1.5 times safety factor.

Never steps on the module or puts heavy objects on it to avoid microcracks of the cells.

Mounting structures and other mechanical parts must be designed and approved to withstand the design wind and snow loads apply for a particular site. Yingli Solar GG modules must not be subjected to forces from the substructure, including forces caused by thermal expansion.

In order to maintain the fire class rating, the distance between the GG module back surface and the roof surface shall be at least 100 mm. This spacing also allows air flow to cool the GG module. Install GG modules with a minimum spacing of 10 mm between neighboring modules to allow for thermal expansion.

The fire rating of a GG module is valid only when mounted in the manner specified in the mechanical mounting instructions of this installation manual.

The installation shall follow the instructions below. If the installation method is different from this manual, please contact Yingli Solar engineers for approval. Please find the installation drawings in the “Module Supplement” .

### Framed GG Module Installation Example

#### Clamps selection

The manufacture of the clamp is responsible for providing an appropriate clamp and installation manual. Clamps length shall not be less than 40 mm (see Figure 10).

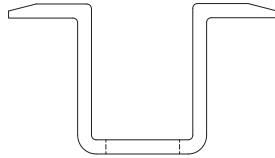

Figure 10: Detail of a clamp

#### Bill of material

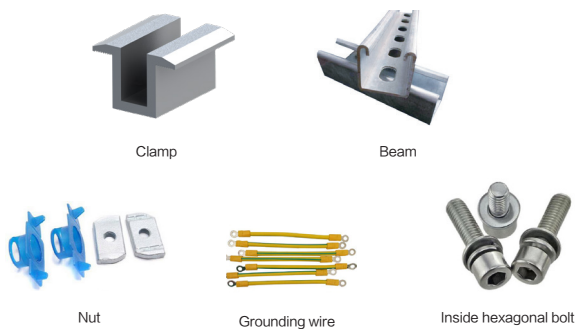

Figure 11: Installation accessories

Table 3: Installation accessories

Type	Dimension (mm)	Material
Clamp	Width x Height x Wall thickness 40 × 10 × 3.0	Aluminium alloy
Beam	Width x Height x Wall thickness 41 × 41 × 2.0	Galvanized steel
Nut	Suitable for M8 screw	Plastic Galvanized steel
Grounding wire	Length x Sectional area 400 × 4.0 mm <sup>2</sup>	Copper
Inside hexagonal bolt	M8 screw Spring washer / Flat washer	SUS 304

#### Installation method

##### Step 1:

Place the clamps on the support beams at correct positions according to the module size. The exact values can be found in the “Supplement” .

##### Step 2:

Place the inside hexagonal bolt into the clamp and screw it partly in the nut. Then insert the two into the beam.

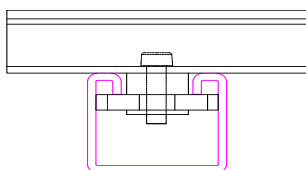

Figure 12: Primary fixation clamp

##### Step 3:

Place the modules and tighten the bolts (Recommended to fix the clamps by M8 screws and tighten the screw with 14~20 N · m torque, see Figure 13).

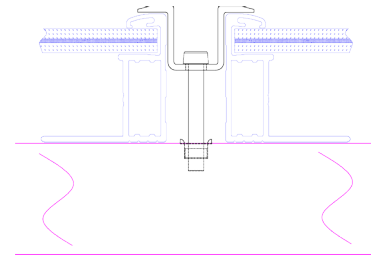

Figure 13: Tighten clamp

##### Step 4:

Connect the frames by grounding wires (Recommended to fix by M4 screw and tighten the screw with 4 N · m torque), then make it earthing reliably.

Successively fasten clamps and connect framed GG modules (see Figure 14).

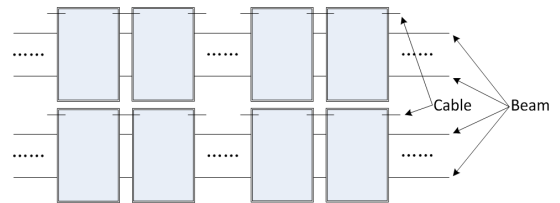

Figure 14: Framed GG modules

## MAINTENANCE

### General

Yingli Solar recommends that PV systems be periodically inspected by the installer or other qualified person.

The purpose of the PV system inspection is to ensure that all system components are functioning properly. At a minimum, this inspection should confirm the following:

- All cables and connector attachments are undamaged and properly secured
- No sharp objects are in contact with the GG module surfaces
- GG modules are not shaded by unwanted obstacles and/or foreign material
- Mounting and grounding components are tightly secured with no corrosion

Defects should be addressed immediately.

### Cleaning

Over time, dirt and dust can accumulate on the glass surface of the module, reducing its power output. Yingli Solar recommends periodic cleaning of GG modules to ensure maximum power output, especially in regions with low precipitation.

In order to reduce the potential for electrical and thermal shock, Yingli Solar recommends cleaning GG modules during early morning or late afternoon hours when solar radiation is low and the modules are cooler, especially in regions with hotter temperatures.

Never attempts to clean a GG module with broken glass or other signs of exposed wiring, as this presents a shock hazard.

Clean the glass surface of the GG modules with a soft brush using soft, clean water with a recommended pressure less than 690 kPa, which is typical of most municipal water systems. Water with high mineral content may leave deposits on the glass surface and is not recommended.

Yingli Solar GG modules may contain a hydrophilic antireflective coating on the glass surface to enhance power output and reduce dirt and dust buildup. In order to avoid module damage, do not clean GG modules with a power washer or pressure washer. Do not use steam or corrosive chemicals to facilitate the cleaning of modules. Do not use aggressive tools or abrasive materials that could scratch or damage the glass surface. Failure to comply with these requirements may adversely affect the GG module performance.

Yingli Solar GG modules are designed to withstand high snow loads. However, if removing snow is desired to enhance production, use a brush to gently remove snow. Do not try to remove frozen snow or ice from GG modules.

## DECOMMISSIONING

The dismantling of PV systems must be performed with the same care and safety precautions used during the initial installation. The PV system can generate hazardous voltage even after the system has been disconnected. Follow safety regulations for working with live electrical equipment.

## RECYCLING

Yingli Solar is a member of PV Cycle, the European association for voluntary take back and recycling of PV modules. Please contact PV Cycle at [www.pvcycle.org](http://www.pvcycle.org) for details regarding the recycling process.

Meaning of crossed-out wheeled dustbin: 

Do not dispose of electrical appliances as unsorted municipal waste, use separate collection facilities.

Contact your local government for information regarding the collection systems available.

If electrical appliances are disposed of in landfills or dumps, hazardous substances can leak into the groundwater and get into the food chain, damaging your health and well-being.

When replacing old appliances with new ones, the retailer is legally obligated to take back your old appliance for disposals at least free of charge.

Yingli Energy (China) Company Limited  
service@yingli.com  
Service hotline: +86-312-8922216  
YLD\_IM\_YLM 3.0\_GG\_EN\_V04



Revision date: Jun. 18th, 2023 | Applicable for IEC certified products

The information in this supplement is believed to be reliable, but does not constitute an expressed or implied warranty. Yingli Solar reserves the right to make changes to its PV modules and other products, their specifications, or this supplement without prior notice.

This supplement to the installation manual does not contain information about some older module series no longer being manufactured by Yingli Solar. If you require information about such modules, please contact Yingli Solar.

## MODULE TYPES

Family	YLM-J 3.0 PRO		
Type	YLxxxDF54 e/2 xxx=385-415	YLxxxDF66 e/2 xxx=470-505	YLxxxDF72 e/2 xxx=510-555
	YLxxxDL54 e/2 xxx=385-415	YLxxxDL66 e/2 xxx=470-505	YLxxxDL72 e/2 xxx=510-555
Max. system voltage	1500 V	1500 V	1500 V
Family	YLM 3.0 PLUS		
Type	YLxxxDF60 f/2 xxx=580-605	YLxxxDF66 f/2 xxx=635-670	
Max. system voltage	1500 V	1500 V	

## ELECTRICAL CHARACTERISTICS

Nameplate ratings are average values. The electrical characteristics are within +/- 10 percent of the indicated values of I<sub>sc</sub>, V<sub>oc</sub>, and P<sub>max</sub> under Standard Test Conditions (irradiance of 1000 W/m<sup>2</sup>, AM 1.5 spectrum, and a cell temperature of 25°C). Refer to module datasheets or log on ([yinglisolar.com](http://yinglisolar.com)) for the latest electrical characteristics. Please refer to Table 1 to see which power classes actually exist for which module series.

# INSTALLATION METHOD

## 1. Mounting hole installation (fixed bracket)

Type	Mechanical load (Pa)	Safety factor	Schematic diagram
Purlin perpendicular to long-side frame	+3600 - 1600	1.5	
Purlin parallel to long-side frame	+1600 - 1600	1.5	

### Notes:

- To maximize mounting longevity, Yingli Solar strongly recommends the use of corrosion proof (stainless steel) attachment hardware.
- To check whether the surface of the beam is flat and smooth, or add rubber pads on the beam to prevent the module from being crushed when it is pressed down.
- Parts in contact with the modules should use flat stainless steel washers of minimum 1.4 mm thickness with an minimum outer diameter of 15.57 mm.
- Modules can be attached using the mounting holes (2 holes of  $\phi 9 \times 14$  mm of one long-side frame,  $\geq 1300$  mm spacing) on the back of the module frame, by fixing the module to the support rails with bolts.
- Secure the module in each mounting location with M8 bolts and matching flat washers, spring washers and nuts, and tighten to a torque of  $14\sim 20$  N · m. The tightening steps as follows: use torque wrench to tighten nut to target torque, nut loosen  $90\sim 180$  degrees, finally tighten the nut to the target torque and reduce the torque attenuation.

## 2. Mounting hole installation (1P tracker)

Type	Mechanical load (Pa)	Safety factor	Schematic diagram
Purlin parallel to long-side frame	+1600 - 1600	1.5	

### Notes:

- To maximize mounting longevity, Yingli Solar strongly recommends the use of corrosion proof (stainless steel) attachment hardware.
- Parts in contact with the modules should use flat stainless steel washers of minimum 1.4 mm thickness with an minimum outer diameter of 15.57 mm.
- Modules can be attached using the mounting holes (2 holes of  $\phi 7 \times 10$  mm of one long-side frame, 400 mm spacing for special tracker, or 2 holes of  $\phi 9 \times 14$  mm of one long-side frame, spacing  $\geq L/3$ , L represents the length of the long side of the module) on the back of the module frame, by fixing the module to the support rails with bolts.
- Secure the module in each mounting location with 2 M6 bolts or 2 M8 bolts, and matching flat washers, spring washers and nuts, and tighten to a torque of  $14\sim 20$  N · m. The tightening steps as follows: use torque wrench to tighten nut to target torque, nut loosen  $90\sim 180$  degrees, finally tighten the nut to the target torque and reduce the torque attenuation.

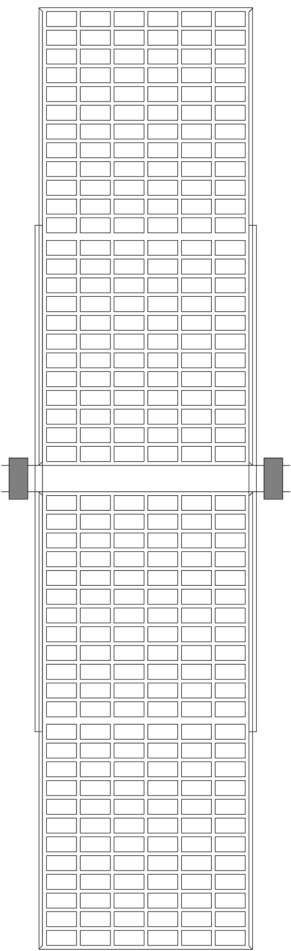

3. Mounting hole installation (2P tracker)

Type	Mechanical load (Pa)	Safety factor	Schematic diagram
Purlin parallel to long-side frame	+1600 - 1600	1.5	

Notes:

- To maximize mounting longevity, Yingli Solar strongly recommends the use of corrosion proof (stainless steel) attachment hardware.
- Parts in contact with the modules should use flat stainless steel washers of minimum 1.4 mm thickness with an minimum outer diameter of 15.57 mm.
- Modules can be attached using the mounting holes (the number of mounting holes used for a single long-side frame  $\geq 2$ , including at least one  $\phi 7 \times 10$  mm hole) on the back of the module frame, by fixing the module to the support rails with bolts.
- Secure the module in each mounting location with M6 and M8 bolts, and matching flat washers, spring washers and nuts, and tighten to a torque of 14~20 N · m. The tightening steps as follows: use torque wrench to tighten nut to target torque, nut loosen 90~180 degrees, finally tighten the nut to the target torque and reduce the torque attenuation.

#### 4. Clamp installation

Type	Mechanical load (Pa)	Safety factor	Schematic diagram
Purlin perpendicular to long-side frame	+3600 - 1600	1.5	
Purlin parallel to long-side frame	+1600 - 1600	1.5	

#### Notes:

- To maximize mounting longevity, Yingli Solar strongly recommends the use of corrosion proof (stainless steel) attachment hardware.
- To check whether the surface of the beam is flat and smooth, or add rubber pads on the beam to prevent the module from being crushed when it is pressed down.
- L represents the length of the long side of the module, the described distances are from the module edge to the middle of the clamp.
- The long-side frames of the module are fixed to the mounting beam or rail by at least 4 clamps that can be fitted with M8 bolts.
- The length of the clamp  $\geq 40$  mm, and the module frame to maintain at least 7 mm but not more than 10 mm overlap part, could not contact with the front glass, shall not make the frame deformation, and should avoid the shading effect of the clamp.
- Tighten M8 bolts to a torque of 14~20 N · m. The tightening steps as follows: use torque wrench to tighten nut to target torque, nut loosen 90~180 degrees, finally tighten the nut to the target torque and reduce the torque attenuation.

## TRANSFER REQUIREMENTS

It is strictly forbidden for people to stand on both sides of the forklift during the operation, and there is a risk of the box falling over and causing injury to people if the operation speed is too fast, and the stacking of boxes is strictly forbidden.

When lifting, need to use lifting tools with sufficient tension to ensure that the center of gravity of the box is stable and to make suitable support structures on the top of the package, such as wooden boards with the same length and width as the package, to ensure that the top of the modules is not squeezed.

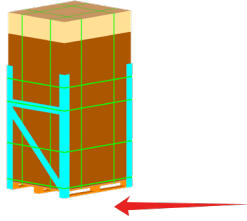

1. Forks enter in the direction of the long side of the pallet, close to the pallet and prohibit slamming against the modules.



2. Safety ropes are required to secure the modules to the forklift with a tensile strength greater than 2000 kgf.

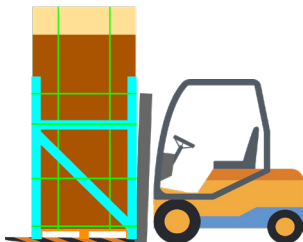

3. When placing it, need to wait for the packing box to be stable before untying the safety rope.

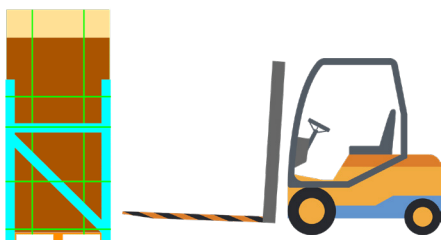

4. Make sure the pallet is separated from the forks and then exit slowly.

### Notes:

- Fork length needs to be more than 1.1 m, gantry height needs to be more than 1.7 m and width more than 1.5 m, gantry can withstand more than 1.5 tons pressure.
- The top of the gantry needs to be placed with cushioning material.
- These transfer requirements apply to upright packaging modules.

## UNPACKING INSTRUCTIONS

Before unpacking, please check whether the product serial number and information on the external box are correct, read the unpacking instructions carefully, prohibit the use of customized unpacking methods, prohibit violent removal to avoid scratching the modules, please refer to the recommended unpacking steps and tools. Unpacking work must be operated by 2 or more people, wear cut-proof insulated gloves, and other labor protection requirements of PV plant construction specifications need to be met.

Unpacking must be done with anti-tilting brackets, please contact your customer manager for the specific requirements of the anti-tilting bracket.

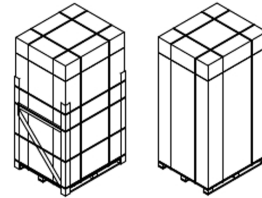

1. Place the package on the flat working ground, cut the packing belts and remove the wooden brackets.

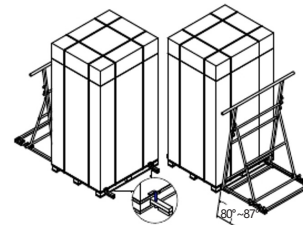

2. Pass the forearm of the anti-tilting bracket through the pallet, insert the two bolts into the front round hole of the anti-tilting bracket, and adjust the support angle of the anti-tilting bracket so that the angle with the ground is between 80° and 87°.

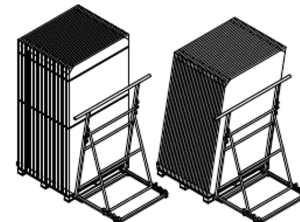

3. Remove the packing belts and carton (the cardboard on one side of the anti-tilting bracket can be retained), leaving only 1 or 2 internal belts, then carefully push the modules so that they rest diagonally against the anti-tilting bracket.

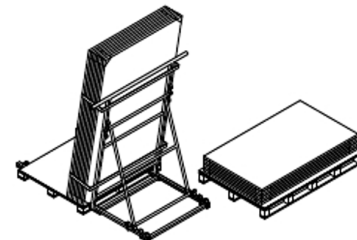

4. Two people work together to carry the modules one by one, if there are any left over, secure the remaining modules to the anti-tilting bracket with tie-downs or place them flat on a pallet (no more than 20 pieces per pallet).

### Note:

- These unpacking instructions apply to upright packaging modules.